

DRAWING REVISIONS (RELEASE DATE ON FILE)			
REV	DOCUMENT	APP	APPROVAL DATE
B	CO 3274	KR	7/18/16

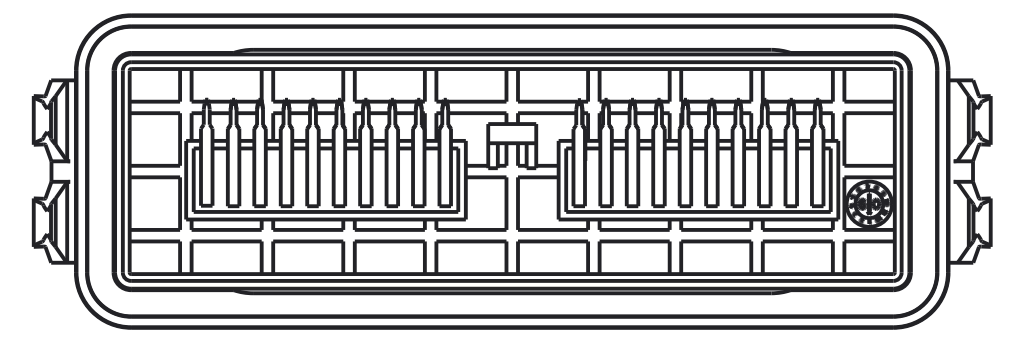
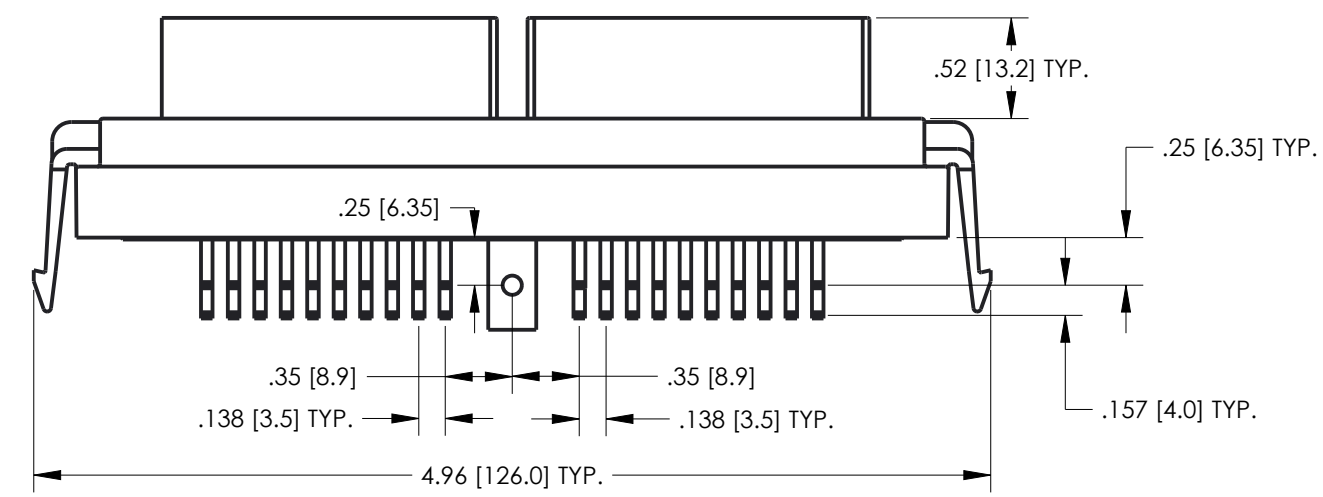
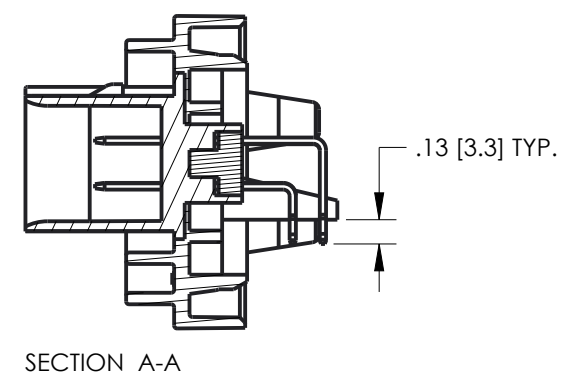
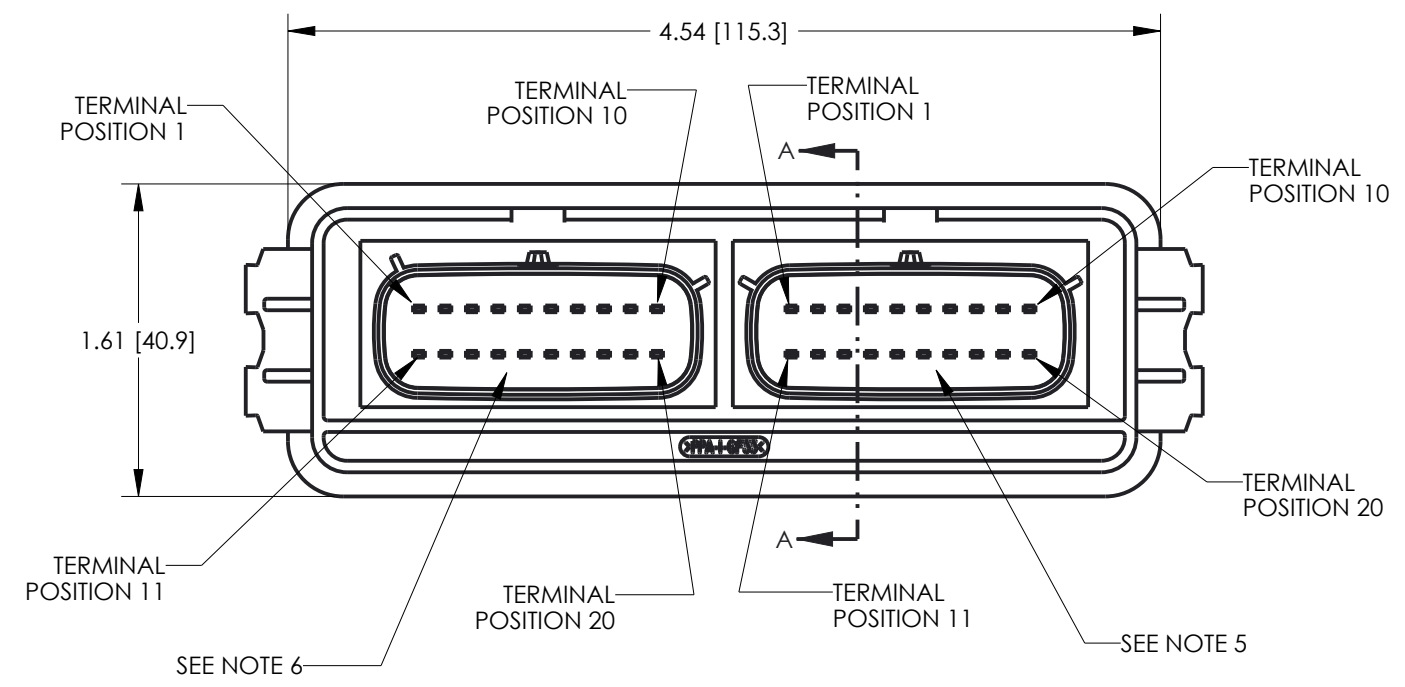

- NOTES:
- DIMENSIONS ARE IN INCHES EXCEPT DIMENSIONS INSIDE [XX] ARE IN mm. ALL DIMENSIONS ARE FOR REFERENCE ONLY.
 - MATERIALS:
HEADER INSULATOR: 30% GLASS FILLED POLYMER, COLOR BLACK.
TERMINAL BLADES: 1.5mm BRASS WITH TIN OVER NICKEL PLATING.
 - HEADERS ARE REFLOW OR WAVE SOLDERING PROCESS ROHS COMPLIANT.
 - SEE SHEET 2 FOR PCB DETAILS.
 - RIGHT SIDE MATES WITH MOLEX FEMALE CONNECTOR PART NUMBER 33472-2001 (COLOR BLACK).
 - LEFT SIDE MATES WITH MOLEX FEMALE CONNECTOR PART NUMBER 33472-2002 (COLOR GRAY).

UNITS ENGLISH INCHES		DESIGN ENGINEER K. ROSBOROUGH	DATE 07/29/14	CINCH 1700 FINLEY RD LOMBARD, IL. 60148 MODELED BY: K. ROSBOROUGH	
DO NOT SCALE DRAWING		PRO/E		TITLE MODICE ME-MX 40 POSITION ASSEMBLY	
UNLESS OTHERWISE SPECIFIED: ALL DIMENSIONS ARE IN INCHES		APPROVALS ON FILE		CONTROL SPEC NUMBER	
FILLET/RADII .02 MAX.	TOLERANCES .X ± .1 XX ± .01 XXX ± .005 ANGULAR ± .5°	MATERIAL NOTED		PROJECT NUMBER A15123	
CONFIDENTIAL THIS DOCUMENT IS THE PROPERTY OF CINCH. NEITHER THIS DOCUMENT NOR ANY OF THE INFORMATION CONTAINED IN IT MAY BE DUPLICATED OR DISCLOSED WITHOUT PRIOR WRITTEN CONSENT OF CINCH. ©COPYRIGHT 2014 CINCH		CAD FILE NUMBER 5810140011S		DRAWING NUMBER 581 01 40 011 S	
		CAGE IDENT NO. 71785	SIZE B	SCALE 1:1	SHEET 1 OF 2

PCB TOP SIDE

PCB BOTTOM SIDE

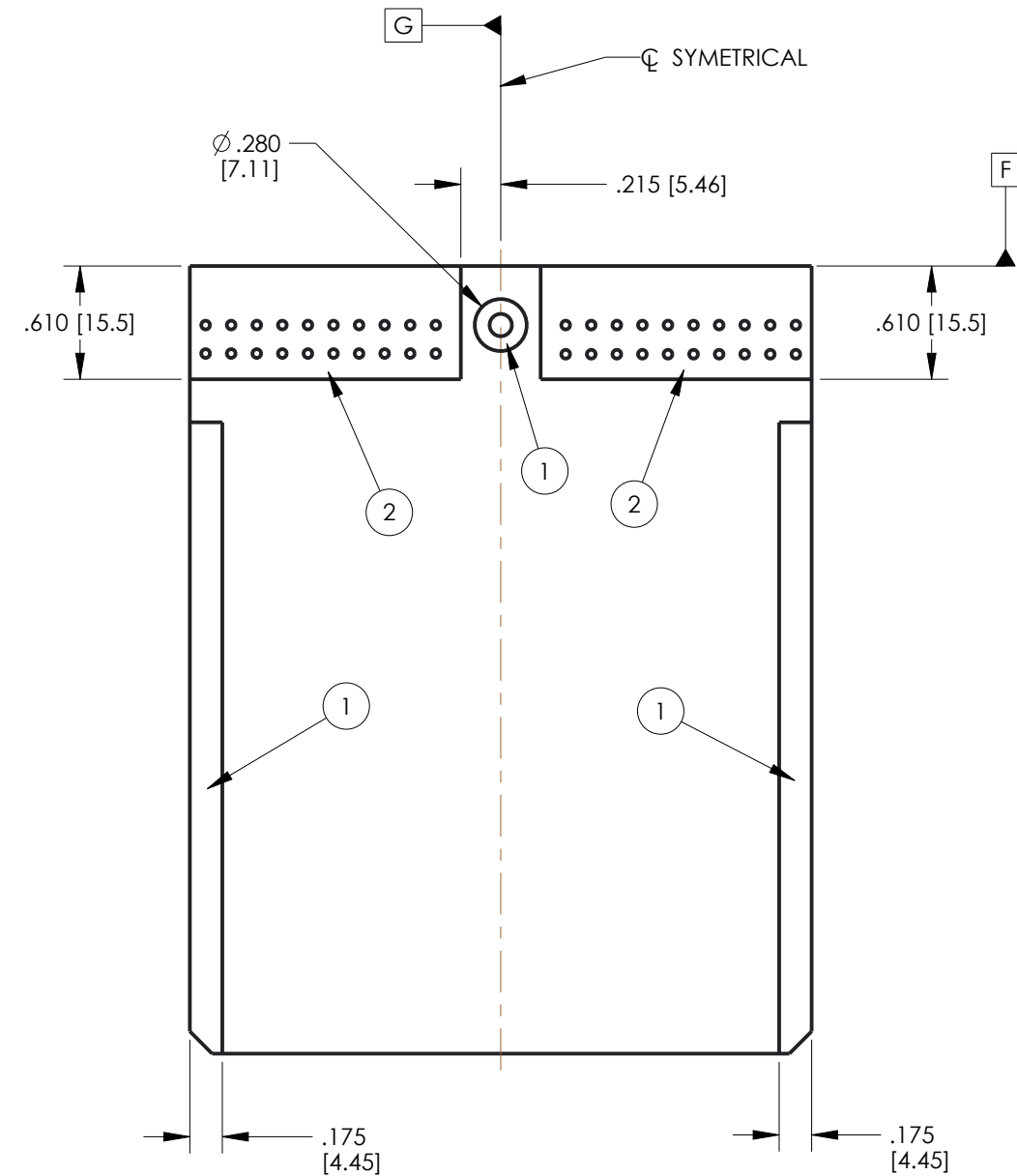
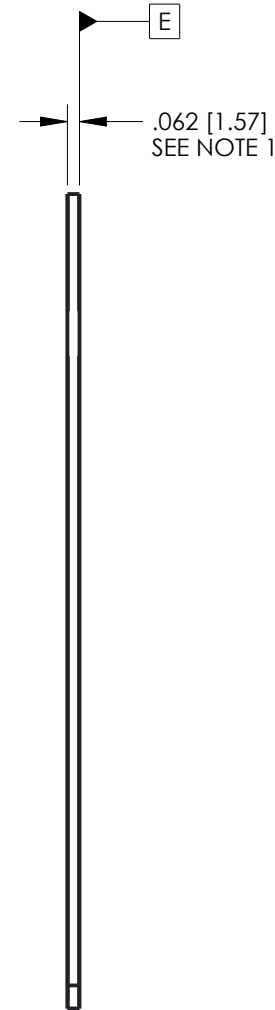
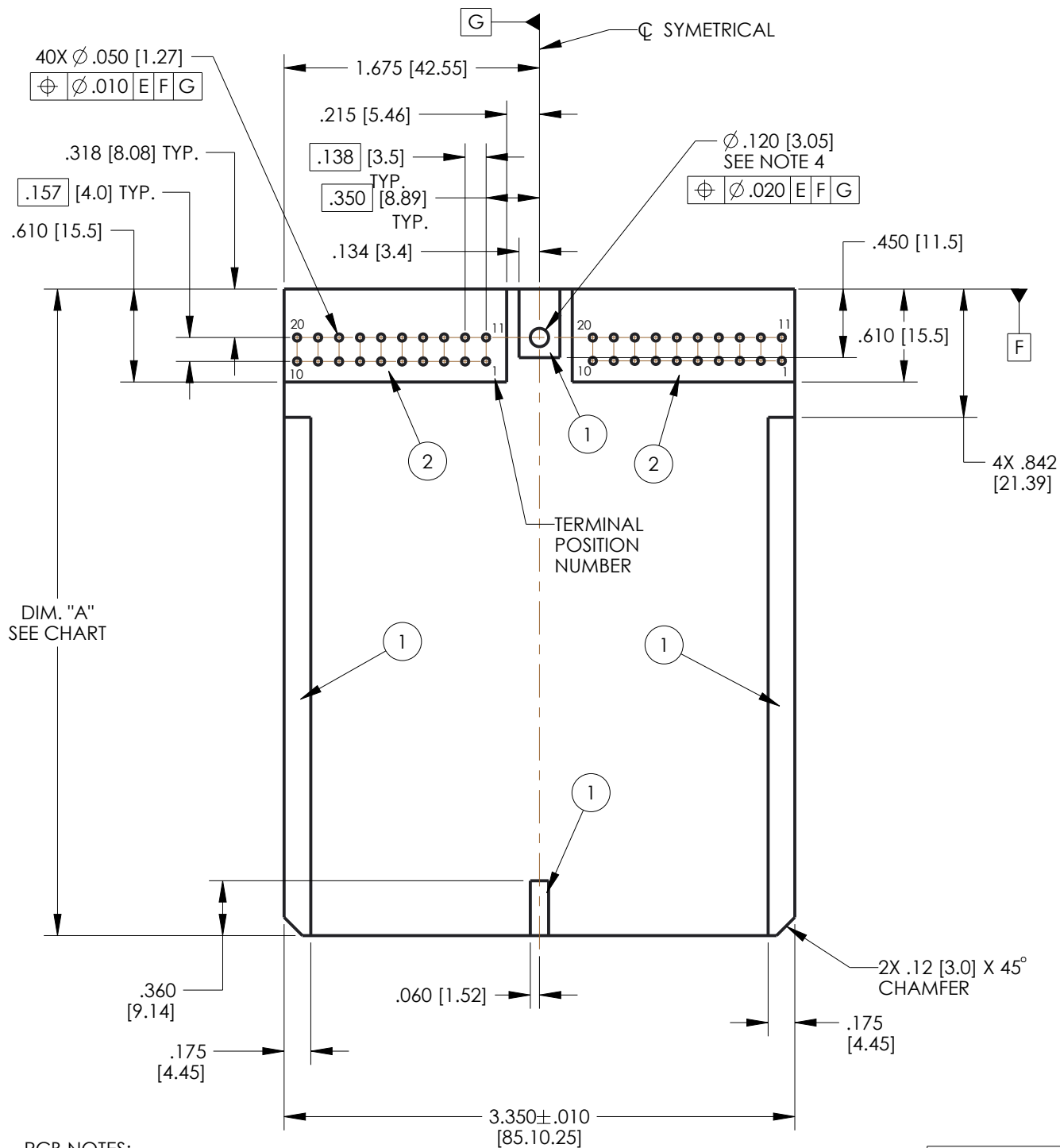

PCB NOTES:

- 1 SUGGESTED PCB THICKNESS .062 [1.57].
- 2 AREAS INDICATED BY (1) ARE COMPONENT AND TRACE KEEP OUT AREAS.
- 3 AREAS INDICATED BY (2) ARE COMPONENT KEEP OUT AREAS.
- 4 SUGGESTED SCREW TO SECURE PCB TO HEADER: #4 THREAD CUTTING SCREW (TYPE 23 OR SIMILAR) TORQUED TO 2-3 IN-LBS [0.23-0.34 N-m].

RECOMMENDED PCB LENGTH

DIM. "A" (SEE DRAWING)	USE WITH ENCLOSURE	
	PART NUMBER	DESCRIPTION
4.242±0.015 [107.75±0.38]	581 01 30 065	ME
	581 01 30 075	ME WITH BREATHER
2.542±0.015 [64.57±0.38]	581 01 30 090	MINI ME
	581 01 30 095	MINI ME WITH BREATHER

UNITS ENGLISH INCHES		CINCH		1700 FINLEY RD LOMBARD, IL. 60148	
DO NOT SCALE DRAWING		TITLE MODICE ME-MX 40 POSITION ASSEMBLY			
UNLESS OTHERWISE SPECIFIED: ALL DIMENSIONS ARE IN INCHES		SCALE 1:1			
FILLET/RADIUS .02 MAX.		TOLERANCES .X ± .1 .XX ± .01 .XXX ± .005 ANGULAR ± .5°		DRAWING NUMBER 581 01 40 011S	
CONFIDENTIAL THIS DOCUMENT IS THE PROPERTY OF CINCH. NEITHER THIS DOCUMENT NOR ANY OF THE INFORMATION CONTAINED IN IT MAY BE DUPLICATED OR DISCLOSED WITHOUT PRIOR WRITTEN CONSENT OF CINCH. ©COPYRIGHT 2014 CINCH		CAD FILE NUMBER 5810140011S	SIZE B	SCALE 1:1	REV B
		CAGE IDENT NO. 71785	SCALE 1:1	SHEET 2 OF 2	