

8 7 6 5 4 3 2 1

PLUG

SOCKET

DRAWING REVISIONS (RELEASE DATE ON FILE)			
REV	DOCUMENT	APP	APPROVAL DATE
1	SALES DRAWING	JW	TBD

NO. OF CONTACTS	JACKPOST THREAD SIZE	"L" DIMENSION
9 THRU 51	2-56 UNC-2B	.190/.185
100	4-40 UNC-2B	.185/.175

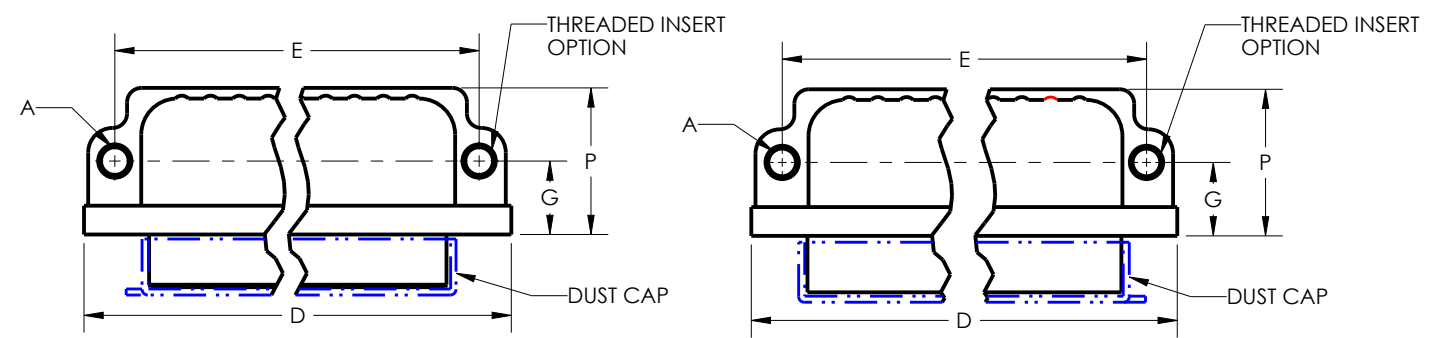

- MEETS ALL APPLICABLE REQUIREMENTS OF MIL-DTL-83513
- FOR OTHER DIMENSIONS, FEATURES AND CHARACTERISTICS, PLEASE SEE CINCH WEBSITE - www.cinch.com
- OTHER CONFIGURATIONS AVAILABLE UPON REQUEST

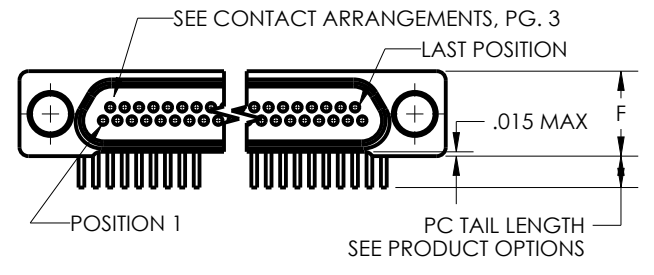
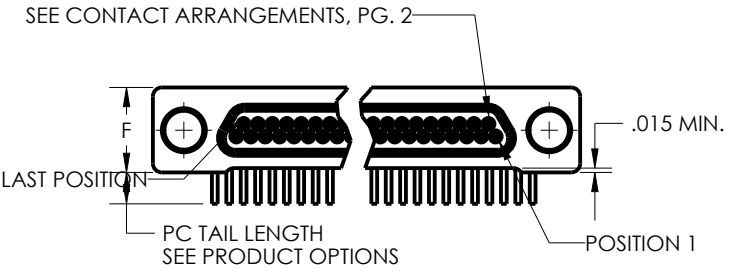

PRODUCT OPTIONS

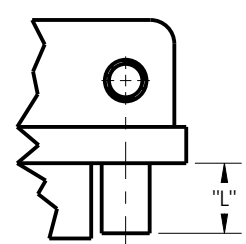
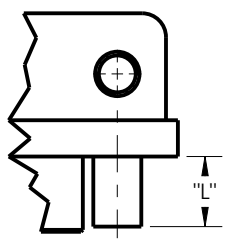
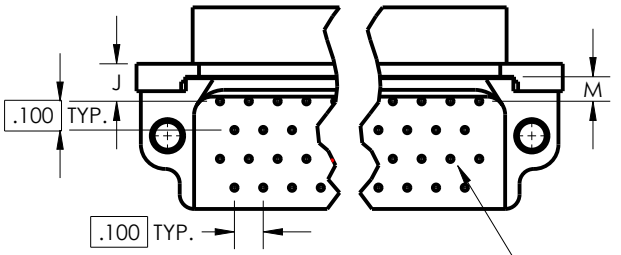
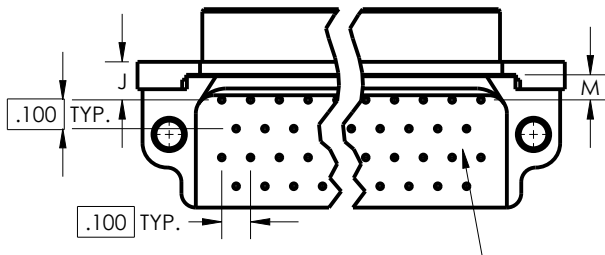
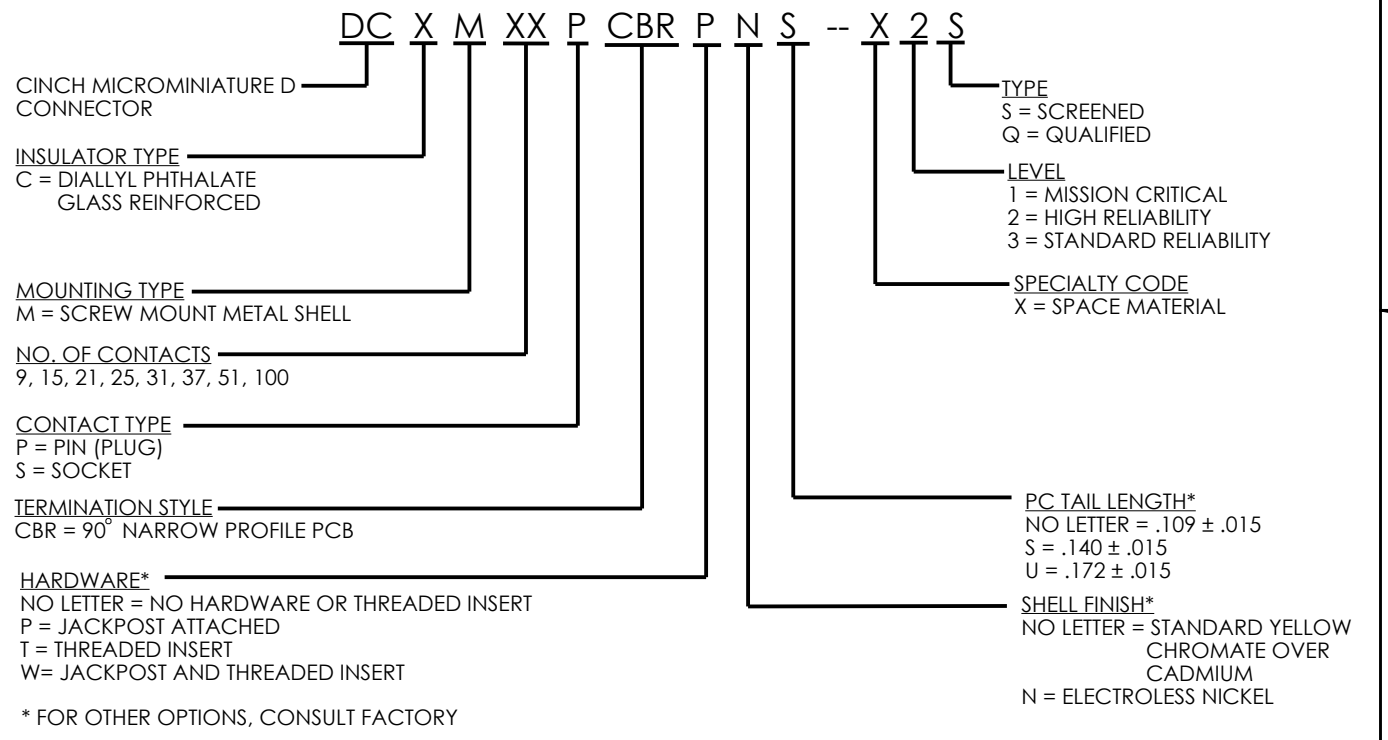

NO. OF CONTACTS	A ± .005	D MAX.	E ± .005	F MAX.	G ± .010	J ± .010	M ± .010	P MAX.
9	∅.096	.785	.565	.308	.250	.230	.180	.420
15		.935	.715					
21		1.085	.865					
25		1.185	.965					
31		1.335	1.115					
37	1.485	1.265	.520					
51	1.435	1.215		.351	.300	.150	.100	.650
100	∅.125	2.175		1.800	.394	.400	.200	.150

ENGLISH INCHES CATALOG DRAWING <small>UNLESS OTHERWISE SPECIFIED: ALL DIMENSIONS ARE IN INCHES</small>		PRO/E DESIGN ENGINEER J WARRAICH DATE 2/1/24	CINCH 1700 FINLEY RD LOMBARD, IL 60148 TITLE DURACON SPACE SCREENED PLUG AND SOCKET CONNECTORS NARROW PROFILE, CBR SERIES
CONFIDENTIAL <small>THIS DOCUMENT IS THE PROPERTY OF CINCH. NEITHER THIS DOCUMENT NOR ANY OF THE INFORMATION CONTAINED IN IT MAY BE DUPLICATED OR DISCLOSED WITHOUT PRIOR WRITTEN CONSENT OF CINCH. ©COPYRIGHT 2009 CINCH</small>		APPROVALS ON FILE	
CAD FILE NUMBER SS_RIGHT_ANGLE_PCB CAGE IDENT NO. 71785	DRAWING NUMBER SS_RIGHT_ANGLE_PCB SIZE B	MATERIAL SPEC NUMBER FINISH SCALE NONE	CONTROL SPEC NUMBER PROJECT NUMBER SHEET 1 OF 3

8 7 6 5 4 3 2 1

CONTACT ARRANGEMENTS OF PLUG CONNECTORS

CONTACT ARRANGEMENTS ARE AS VIEWED FROM ENGAGING FACE
 TERMINATION PATTERNS ARE AS VIEWED FROM BOTTOM OF TERMINAL BLOCK

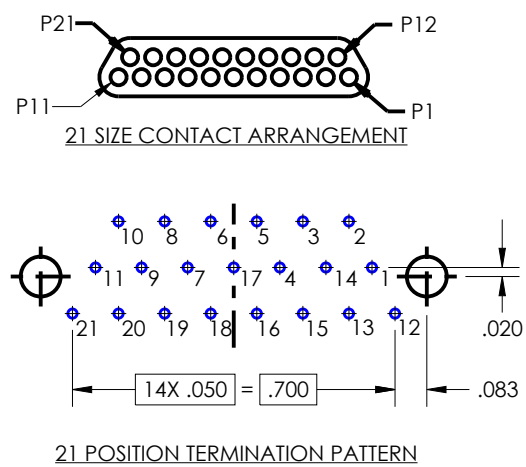
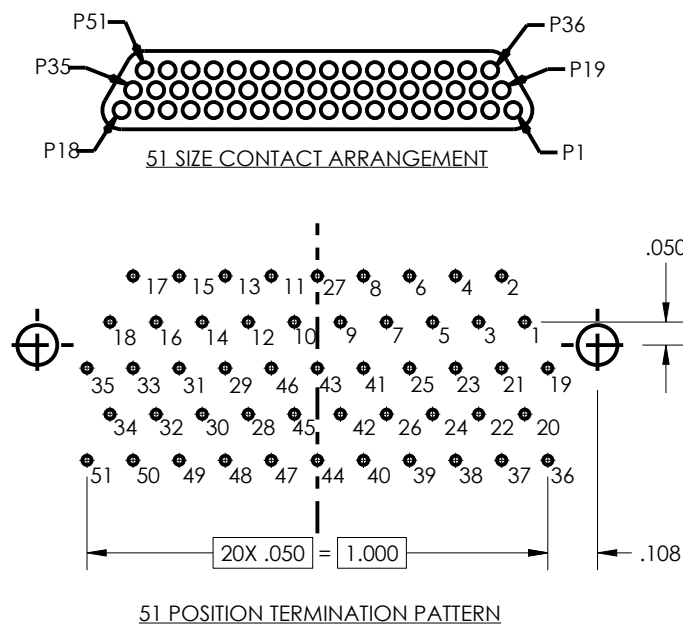
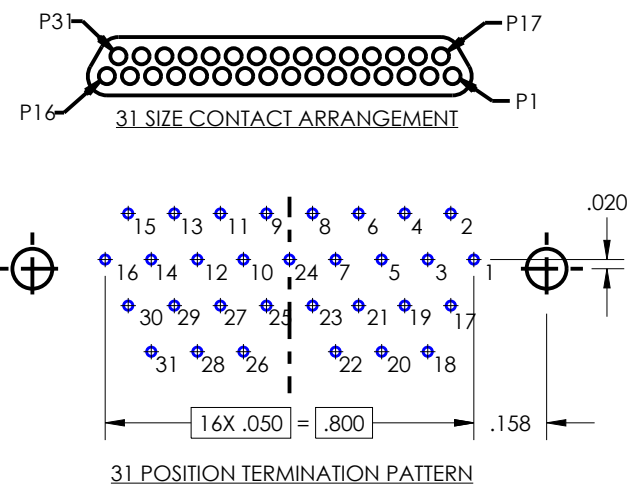
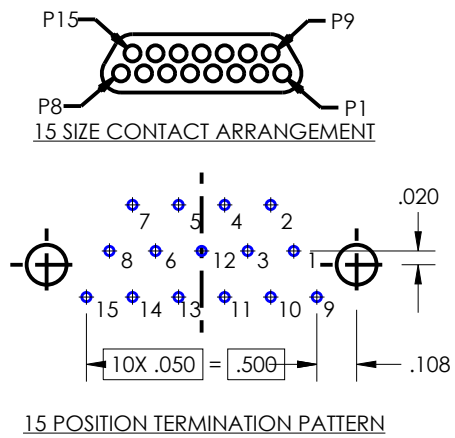
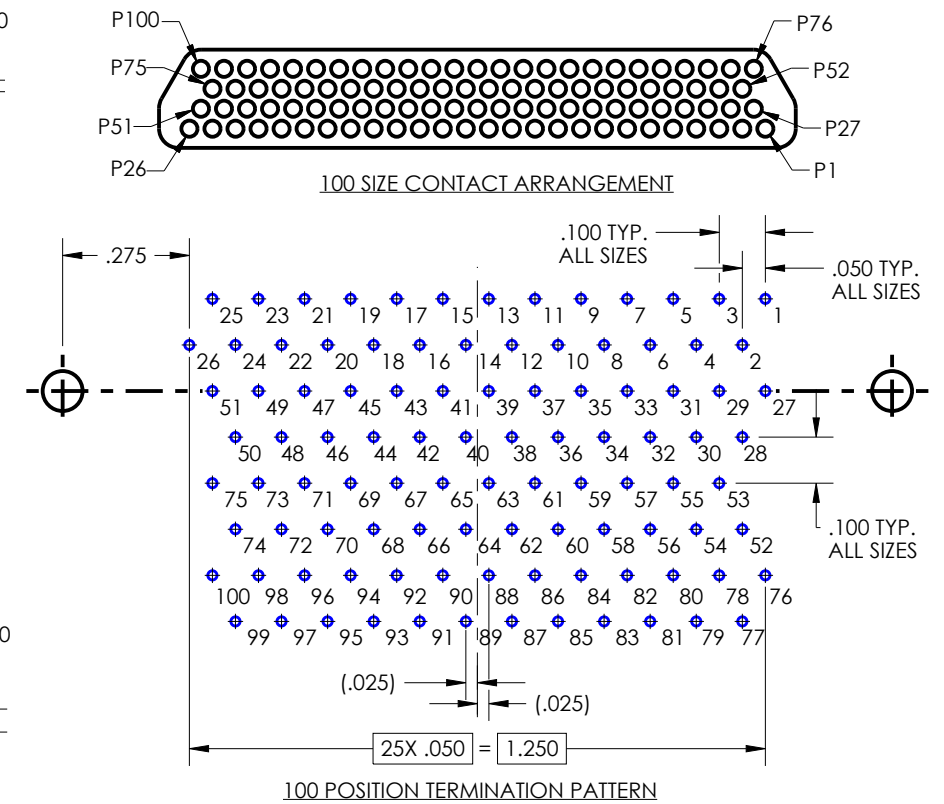
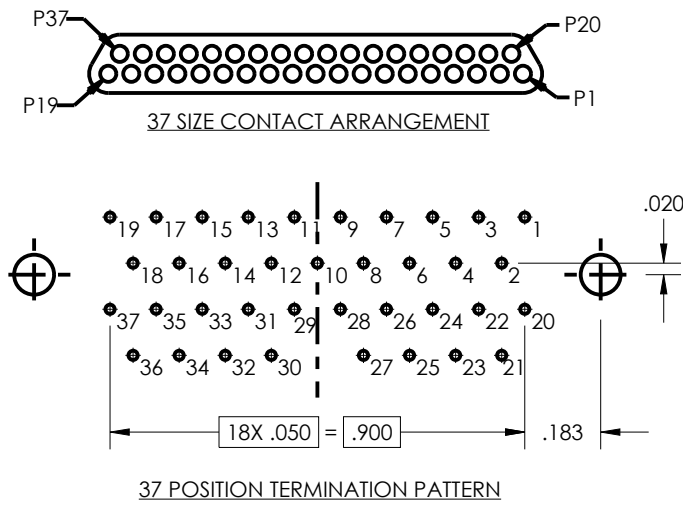
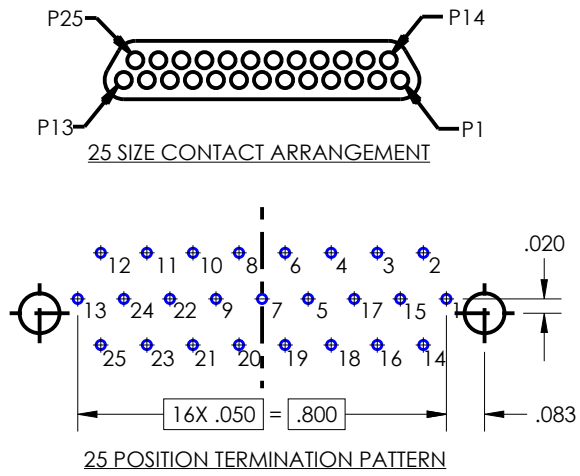
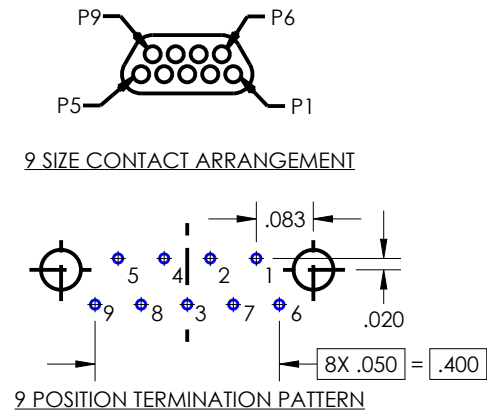

UNITS ENGLISH INCHES	CINCH		1700 FINLEY RD. LOMBARD, IL. 60148
CATALOG DRAWING	TITLE DURACON SPACE SCREENED PLUG AND SOCKET CONNECTORS NARROW PROFILE, CBR SERIES		
UNLESS OTHERWISE SPECIFIED: ALL DIMENSIONS ARE IN INCHES	PRO/E DRAWING		
CONFIDENTIAL THIS DOCUMENT IS THE PROPERTY OF CINCH. NEITHER THIS DOCUMENT NOR ANY OF THE INFORMATION CONTAINED IN IT MAY BE DUPLICATED OR DISCLOSED WITHOUT PRIOR WRITTEN CONSENT OF CINCH. ©COPYRIGHT 2009 CINCH	CAD FILE NUMBER	DRAWING NUMBER	REV
	SS_RIGHT_ANGLE_PCB	SS_RIGHT_ANGLE_PCB	1
	CAGE IDENT NO. 71785	SIZE B	SCALE NONE

CONTACT ARRANGEMENTS OF SOCKET CONNECTORS

CONTACT ARRANGEMENTS ARE AS VIEWED FROM ENGAGING FACE
 TERMINATION PATTERNS ARE AS VIEWED FROM BOTTOM OF TERMINAL BLOCK

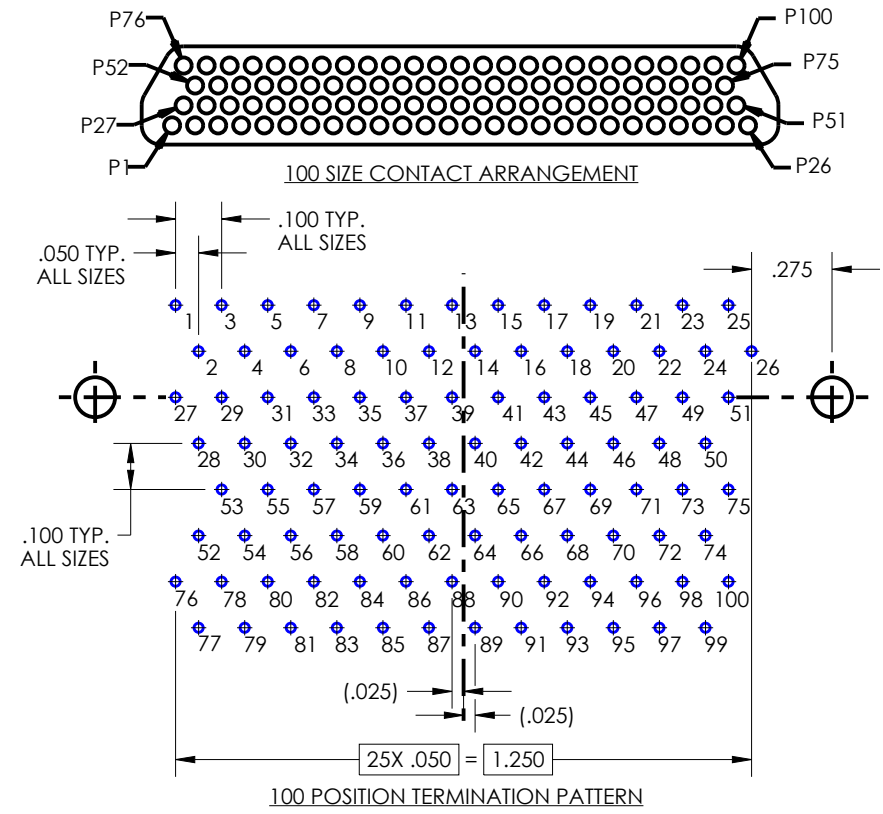
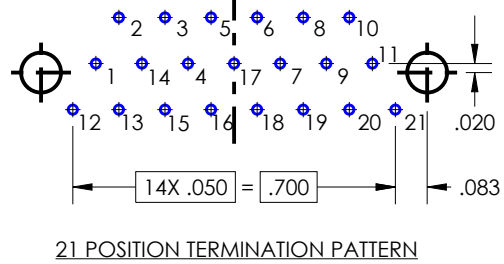
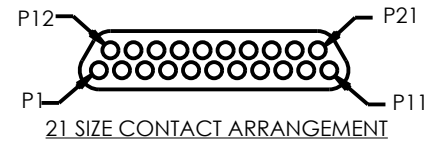
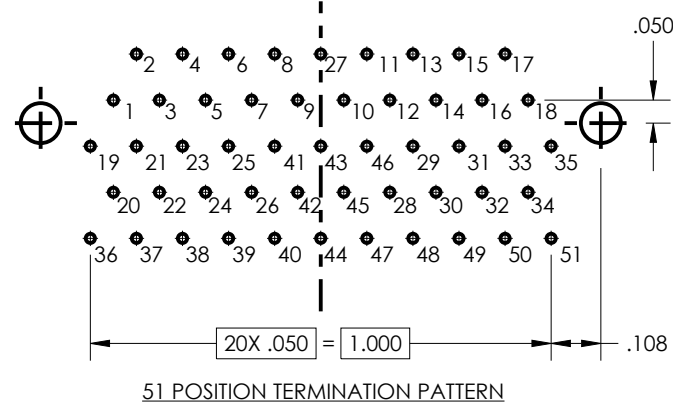
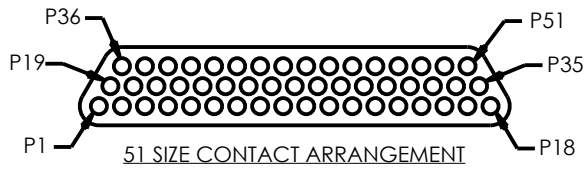
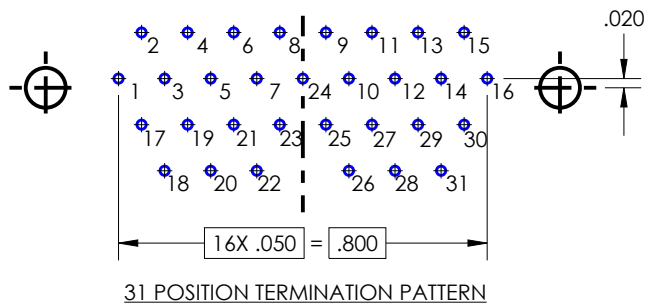
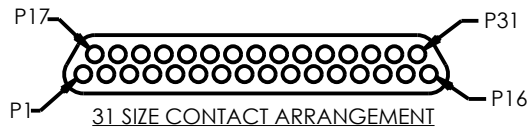
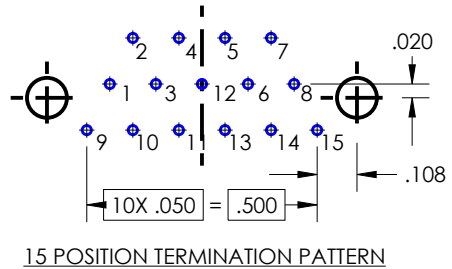
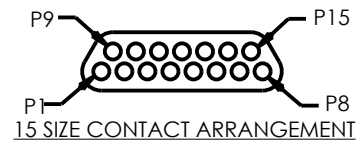
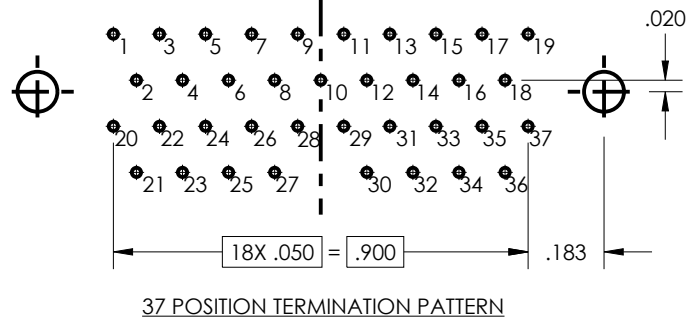
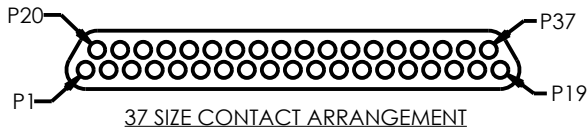
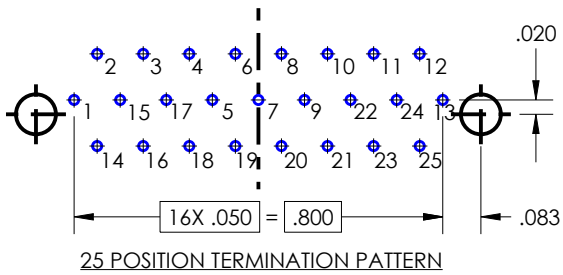
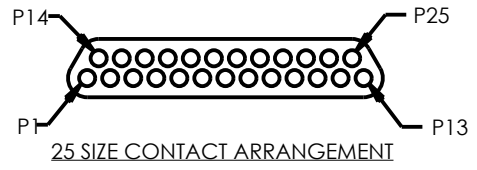
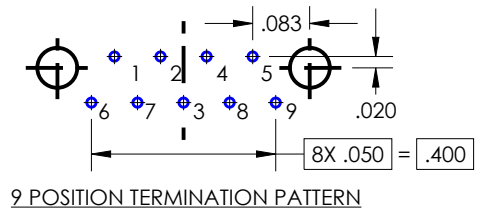
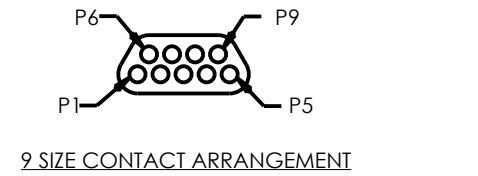

UNITS ENGLISH INCHES	CINCH		1700 FINLEY RD LOMBARD, IL. 60148
CATALOG DRAWING	TITLE DURAON SPACE SCREENED PLUG AND SOCKET CONNECTORS NARROW PROFILE, CBR SERIES		
UNLESS OTHERWISE SPECIFIED: ALL DIMENSIONS ARE IN INCHES	PRO/E DRAWING		
CONFIDENTIAL THIS DOCUMENT IS THE PROPERTY OF CINCH. NEITHER THIS DOCUMENT NOR ANY OF THE INFORMATION CONTAINED IN IT MAY BE DUPLICATED OR DISCLOSED WITHOUT PRIOR WRITTEN CONSENT OF CINCH. ©COPYRIGHT CINCH	CAD FILE NUMBER	DRAWING NUMBER	REV
	SS_RIGHT_ANGLE_PCB	SS_RIGHT_ANGLE_PCB	1
CAGE IDENT NO.	SIZE	SCALE	SHEET 3 OF 3
71785	B	NONE	